

EX-7 series

HITACHI

Reliable solutions

EX5600



HYDRAULIC EXCAVATOR

Model Code: EX5600-7 (Fuel Consumption Optimization)
Engine Rated Power: Cummins: 2 x 1 119 kW (1 520 PS)
MTU: 2 x 1 150 kW (1 563 PS)
Operating Weight: Cummins Loading Shovel: 541 000 kg
Backhoe: 545 000 kg
MTU Loading Shovel: 549 000 kg
Backhoe: 553 000 kg
Bucket: Loading Shovel: ISO Heaped: 29.0 m³
Backhoe: ISO Heaped: 34.0 m³

Model Code: EX5600-7B (Tier 4 Final)
Engine Rated Power: Cummins: 2 x 1 119 kW (1 520 PS)
MTU: 2 x 1 150 kW (1 563 PS)
Operating Weight: Cummins Loading Shovel: 544 000 kg
Backhoe: 549 000 kg
MTU Loading Shovel: 549 000 kg
Backhoe: 553 000 kg
Bucket: Loading Shovel: ISO Heaped: 29.0 m³
Backhoe: ISO Heaped: 34.0 m³

Model Code: EX5600-7E
Power Output: 2 x 860 kW
Bucket: Loading Shovel: ISO Heaped: 29.0 m³
Backhoe: ISO Heaped: 34.0 m³

Introducing the **NEW EX5600-7**

The Hitachi EX-7 series is borne from sheer engineering excellence, balancing innovation with proven design to deliver industry leading excavators.

With simplified maintenance and a focus on operator comfort, Hitachi offers a productive, durable solution for all mining operations.

Incorporating the latest technologies, systems and safety features, the EX5600-7 delivers unrivaled performance and reliability in its class.





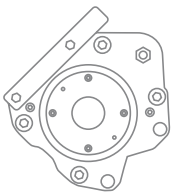

MAIN PUMP ELECTRIC REGULATORS

Individually controlled hydraulic pumps utilize an electric regulator on each main pump, optimizing engine power and lowering fuel consumption to deliver a more efficient performance.

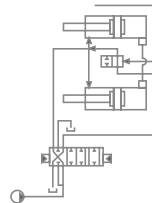

HYDRAULIC REGENERATION CIRCUIT

The new flow regeneration valve fitted to the hydraulic system reduces hydraulic pump demand ultimately reducing the power requirements from the hydraulic system and engine, lowering fuel consumption and improving pump life.

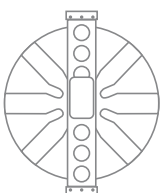

HYDRAULIC OIL COOLER FAN

Redesigned hydraulic oil cooler with variable speed fan requires less power to cool hydraulic oil, resulting in a more reliable hydraulic system with reduced energy demand.

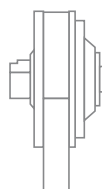

RADIATOR FAN CLUTCH

The radiator fan clutch and variable speed fan are specifically tailored to the engine cooling requirement, resulting in an optimal cooling system with reduced engine horsepower demand and the added benefit of lowering operation noise.

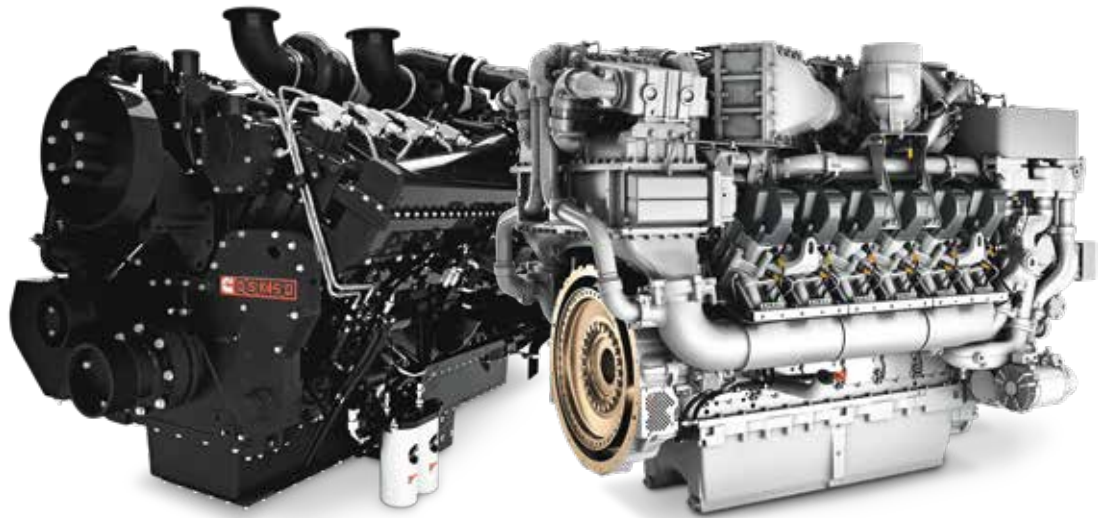

ENGINE OPTIONS

CUMMINS

2xCummins QSK50,16 cylinder, 50L, turbo-charged, after-cooled 1 119 kW(1 520 PS)

Options:

Cummins diesel engine U.S.A. E.P.A. Tier 4 conforming model, with Diesel Exhaust Fluid (DEF) tank

Cummins diesel engine Fuel Consumption Optimization (FCO) model

MTU

2 x MTU 12V4000, 12 cylinder, 57.2 L, turbo-charged after-cooled, 1 150 kW (1 563 PS)

Options:

MTU diesel engine U.S.A. E.P.A. Tier 4 conforming 2-stage turbo-charged model

MTU diesel engine Fuel Consumption Optimization (FCO) single turbo-charged model

HITACHI ELECTRIC

The EX5600-7E electric excavator is available, operating with the Hitachi AC electric motor

Options:

2 x electric motor (860 kW) 50 Hz, 6 000 V, 6 600 V*

2 x electric motor (860 kW) 60 Hz, 6 600 V, 7 200 V*

*Please contact hitachi for other specification request

designed for **SUSTAINABILITY**

The Hitachi EX-7 series utilizes the latest advancements in engine and energy optimization technologies to deliver a customized and sustainable machine, while providing a significant reduction in fuel consumption without compromising productivity.

The EX5600-7 offers a selection of engine models, including the choice of emission configurations to meet regulatory requirements, combined with new electronically controlled hydraulic pumps, optimized cooling package and enhanced hydraulic circuits, to provide unparalleled performance and efficiency.

designed for

PRODUCTIVITY

Engineered from the ground up with advanced technologies to maximize productivity, the EX5600-7 delivers a reliable solution for all operations.

Embracing the Hitachi design philosophy of balanced reliability and productivity, the EX5600-7 optimizes machine performance, providing a consistent and dependable solution to meet the demands of the mining industry.

FRONT ATTACHMENT

With a front attachment design optimized for machine performance, the EX5600-7 can achieve superior productivity under various digging profiles.

The boom and arm are strategically welded, utilizing a full-box section design to evenly distribute stress and provide ease of maintenance.

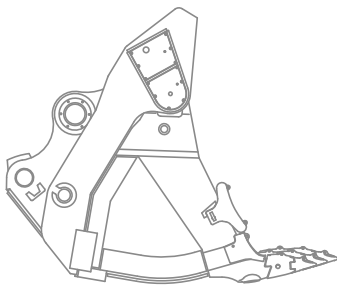

LOADING SHOVEL

The Loading Shovel attachment is equipped with an auto-leveling crowd mechanism that controls the bucket at a constant angle. Complete with floating pin and bush, the bucket has been specifically designed to enhance loading capability with a tilt angle that enhances operational efficiency.

EXCAVATING FORCE

Arm crowding force on ground
1 520 kN (155 000 kgf)

Bucket digging force
1 590 kN (162 000 kgf)

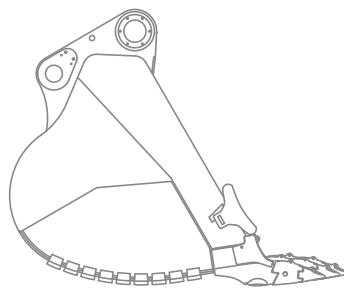

BACKHOE

The Backhoe attachment is designed using computer aided box frame analysis to determine the optimal structure for integrity and longevity. Complete with floating pin and bush, Hitachi buckets are designed to match the geometry of the attachment to maximize productivity.

EXCAVATING FORCE

Arm crowding force on ground
1 300 kN (133 000 kgf)

Bucket digging force
1 480 kN (151 000 kgf)





designed for **SAFETY**

At Hitachi, safety is paramount, that's why safety is a major focus in the new EX-7 series excavators.

Designed and built with improved pathways and handrails, the layout of the EX5600-7 provides for a safer and more maintainable machine. The addition of an on-board inclinometer and the dual isolator switch as standard, deliver a safer working environment than ever before.

ENGINE STOP SWITCHES

Engine stop switches have been placed in easily accessible areas: four in the engine room, one in the pump room, one in the oil cooler room, and one emergency stop switch in the cab.

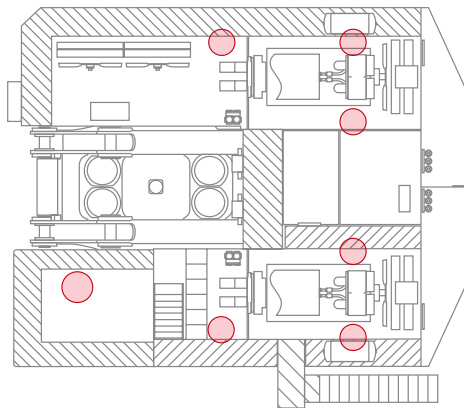

DUAL ISOLATOR SWITCH

The conveniently located dual isolator switch provides the option to deactivate the engine and battery individually.

When inspections and maintenance are required, the battery isolator provides the benefit of isolating both the positive and negative terminals of the battery to provide a safe working environment. The engine isolator deactivates the engine starter motor, while allowing battery power to the electric system for troubleshooting to enhance safety and maintainability.



EMERGENCY ESCAPE CHUTE

An escape chute has been added to the side of the cab for use in an emergency. The chute allows evacuees to descend vertically down from the machine, providing a safe and fast route of escape when all other means of exit are blocked.



ACCESS AND STAIRWAYS

Anti-slip walkways and the specifically designed handrail system reduce the risk of tripping when maneuvering around the machine, and provide ease of access for operators and maintenance personnel.

Wide, gradual gradient, non-slip hydraulic folding stairs allow for easy and safe access to the machine.



ON BOARD INCLINOMETER

The on-board inclinometer assists the operator to work within the safe limits of the machine for optimal performance, with two predetermined safety limits providing extra assurance and confidence. If the first safety limit is exceeded, the operator receives a visual alert prompting them to take corrective action. The alert escalates to an audible alarm if the second safety limit is breached.



PERIMETER MONITORING CAMERAS (OPTIONAL)

Optional perimeter monitoring cameras offer better visibility of the surrounding area, reducing blind spots for the operator. Cameras are located at the front (2) and rear (2) of the excavator and linked to monitors inside the cab.

OPERATOR CABIN

The use of tinted laminated windows to reduce heat, glare and harmful UV rays, and the sound-suppressed cab, further enhance the ergonomic environment, improving operator comfort. The Level II Operator Protective Guard (OPG) provides protection from falling objects, ensuring an added layer of safety and assurance to the operator.



ROLL SCREENS

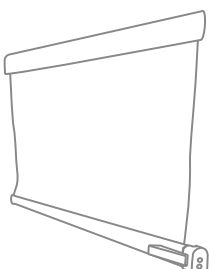

Retractable front and side roll screens provide a more comfortable working environment, protecting the operator from sun glare. Reduced heat buildup in the cab improves the efficiency of the climate controlled air conditioner resulting in a more enhanced operating environment.

CLIMATE CONTROLLED AIR CONDITIONING



The climate controlled air conditioning within the pressurized cab helps overcome environmental extremes. Optimized filtering of interior and exterior air combined with the new flexi-vent system provides a more personalized and balanced environment to meet the demands of the operator.

designed for

OPERATOR COMFORT

The EX5600-7 cabin is designed for a superior operating experience. The ergonomic layout, electronic joysticks, intelligent Multi-Display, air suspension seat and advanced climate control system provide an operating environment conducive to less fatigue and enhanced operator productivity.



MULTI-FUNCTIONAL DISPLAY

Fitted with an LED back-light to improve clarity and reduce glare, the multi-functional display provides key machine information and performance indicators through use of an integrated dial switch interface.



OPERATOR SEAT

Specifically designed for use in the mining industry, the automatic weight-adjusting air suspension seat determines the optimal cushioning effect to match the operator's weight, enhancing comfort and minimizing vibration.



ELECTRONIC JOYSTICKS

Connected to the machine's microprocessor, the integrated electronic joysticks enable precise and almost effortless operation, minimizing operator fatigue and improving operational performance.

designed for

EASE OF MAINTENANCE

Hitachi's unique modular design, spacious passageways and work platforms provide clear access for daily maintenance requirements and major component inspections, resulting in safer and simplified maintenance.

The addition of several new innovative features improve the serviceability of the EX5600-7, reinforcing the ease of maintenance that customers have come to expect from Hitachi.



AUTO-LUBRICATING SYSTEM

Advanced, redesigned auto-lubrication system comes with a 673L large capacity grease tank, new grease pump, in-line grease filter, breather with filter, grease level indicator in the cab and a provision for fitment of a second grease pump in the lubrication tank, providing a more reliable system for more uptime.

CENTRALIZED LUBRICATION SYSTEM

The centralized fast-filling system provides easy access from the ground to refill and evacuate lubricants, water, grease and fuel. The fast-filling system can be fitted with an optional quick coupler.



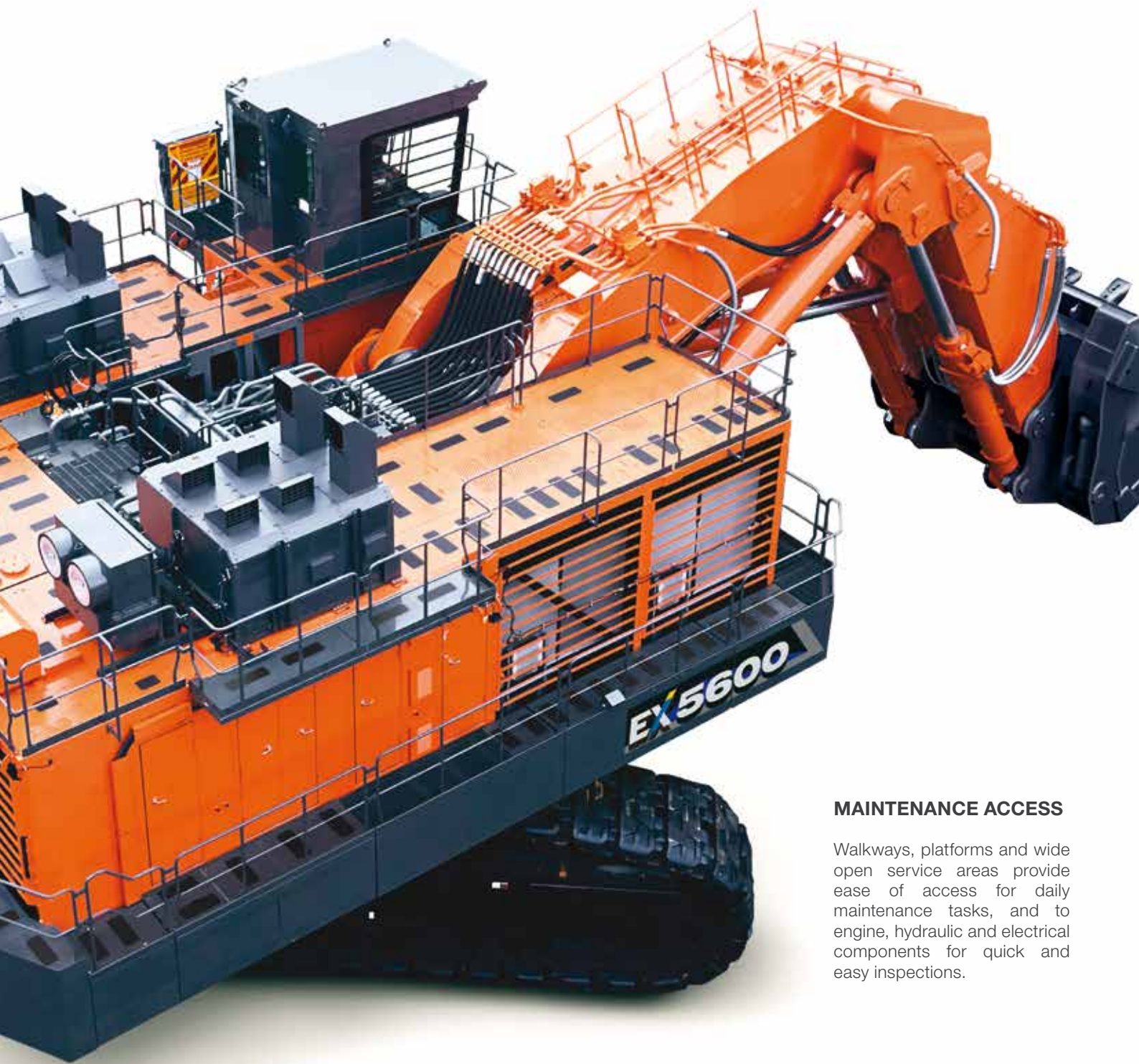

MAINTENANCE ACCESS

Walkways, platforms and wide open service areas provide ease of access for daily maintenance tasks, and to engine, hydraulic and electrical components for quick and easy inspections.



CONTAMINATION SENSORS

Contamination sensors are located on all main hydraulic pumps to detect any contaminants that may cause damage to the hydraulic system. The sensors alert the operator of potential contaminants and also record the fault code in the Data Logging Unit (DLU) with the capability to remotely advise maintenance personnel.

LUBRICATION PIPING COVER

A swing circle cover has been added to the outside of the swing bearing, protecting the lubrication piping from debris damage.



GREASE-LESS CENTER JOINT

The redesigned center joint is self-lubricating utilizing the machine's hydraulic oil, reducing the need for daily maintenance.

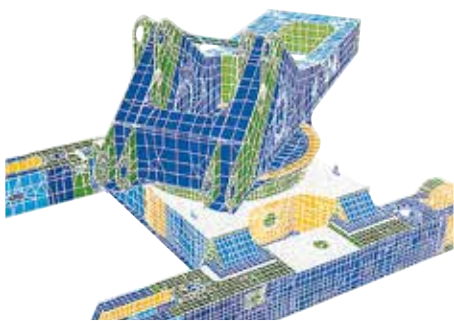

RIGID BOX DESIGN

Computer assisted analysis is used to determine the most effective design for frame longevity to withstand the demands of the mining operation.



CENTER TRACK FRAME

Hitachi's exclusive center track frame delivers optimal stress dispersion through the use of specifically designed castings to reduce welds in critical high stress areas, ensuring a stronger frame with improved durability and reliability.



UPPER ROLLERS

The EX5600-7 undercarriage has three double-sided pedestal-designed upper rollers on each side of the track frame to maintain track shoe clearance and provide protection from debris buildup, reducing shoe and roller wear for a more reliable solution.



designed for
DURABILITY

Designed, built and engineered for the mining industry, Hitachi's EX-7 series excavators offer a productive, reliable solution for all operations.

From the rigid box design to the 3D computer assisted FEA analysis, the EX5600-7 utilizes proven engineering philosophies to deliver a more durable machine.



OIL FILLED ROLLERS & IDLERS

The oil-filled idlers, and upper and lower rollers eliminate the need for daily lubrication, helping reduce maintenance costs.



TRACK SHOES

The proven Hitachi patented track shoe design has been applied to mitigate premature wear of the drive-lugs. Each shoe is induction hardened utilizing Hitachi's unique processes to deliver a superior and more durable solution.



CENTER FRAME UNDERGUARD (OPTIONAL)

The newly designed heavy duty guard protects hoses and accumulators located in the track center frame from rocks and debris ingress, providing extra protection and reliability.



ELECTRONIC CYLINDER STROKE CONTROL

The new on-board electronic controller receives signals from angle sensors fitted to the boom and arm to control the pump flow rate and cylinder speed, reducing the shock at the stroke end of the cylinder cycle. This new feature improves operator comfort and reduces the impact on the cylinders and structures, increasing reliability and productivity.





designed for
RELIABILITY

Evolving from years of operational experience and engineering excellence, the Hitachi EX-7 series of excavators continues to drive innovation within the mining industry. Advanced technology, enhanced durability, improved safety features and operational performance, all combine to make the new EX5600-7 a more reliable mining solution.



FRONT ATTACHMENT HOSES

Hitachi's hose design is based on a cyclic fatigue rate to maximize longevity and improve safety. Front attachment hoses have also been rearranged from the traditional arch style to an underslung configuration, removing the need for clamping, reducing chafing and increasing reliability.



CAB RISER PRESSURIZER

A pressurizer system has been introduced to the cab riser to reduce dust infiltration, maximizing the service life of the electronic components and devices located within.



SOLID CONDUIT WIRE HARNESES

The introduction of solid conduit harnesses and junction boxes prevents dust and moisture ingress, improving longevity. Electrical harnesses between junction boxes can be replaced individually, ultimately reducing maintenance time and cost.



OPERATING LIGHTS

Strategically placed long-life LED working lights provide greater longevity and reliability in night operations.

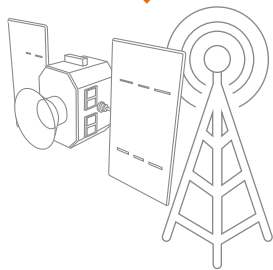

ANTENNA (GPRS) OR
SATELLITE

SATELLITE / GPRS COMMUNICATION (OPTIONAL)

Standard machine information is transmitted daily through either satellite or GPRS (General Packet Radio Service) communication, sending data directly to the Hitachi Global e-Service platform to support the mining operation.

Globale-Service

Global e-Service is a Hitachi web-based platform that sends vital machine information directly to the customer in an easy-to-understand format.

WIRELESS INTERFACE (OPTIONAL)

Detailed machine information can be remotely downloaded from the Data Logging Unit (DLU) via the Wireless Interface Unit (WIU), providing vital operational & performance data.



ON-SITE STAFF



designed for **INTELLIGENCE**

Hitachi's EX-7 excavators connect physical features with digital technologies for seamless and intuitive operation. Extensive onboard sensors, diagnostic tools, real time data and advanced software allow the EX5600-7 to empower personnel with a better understanding of mining operations.

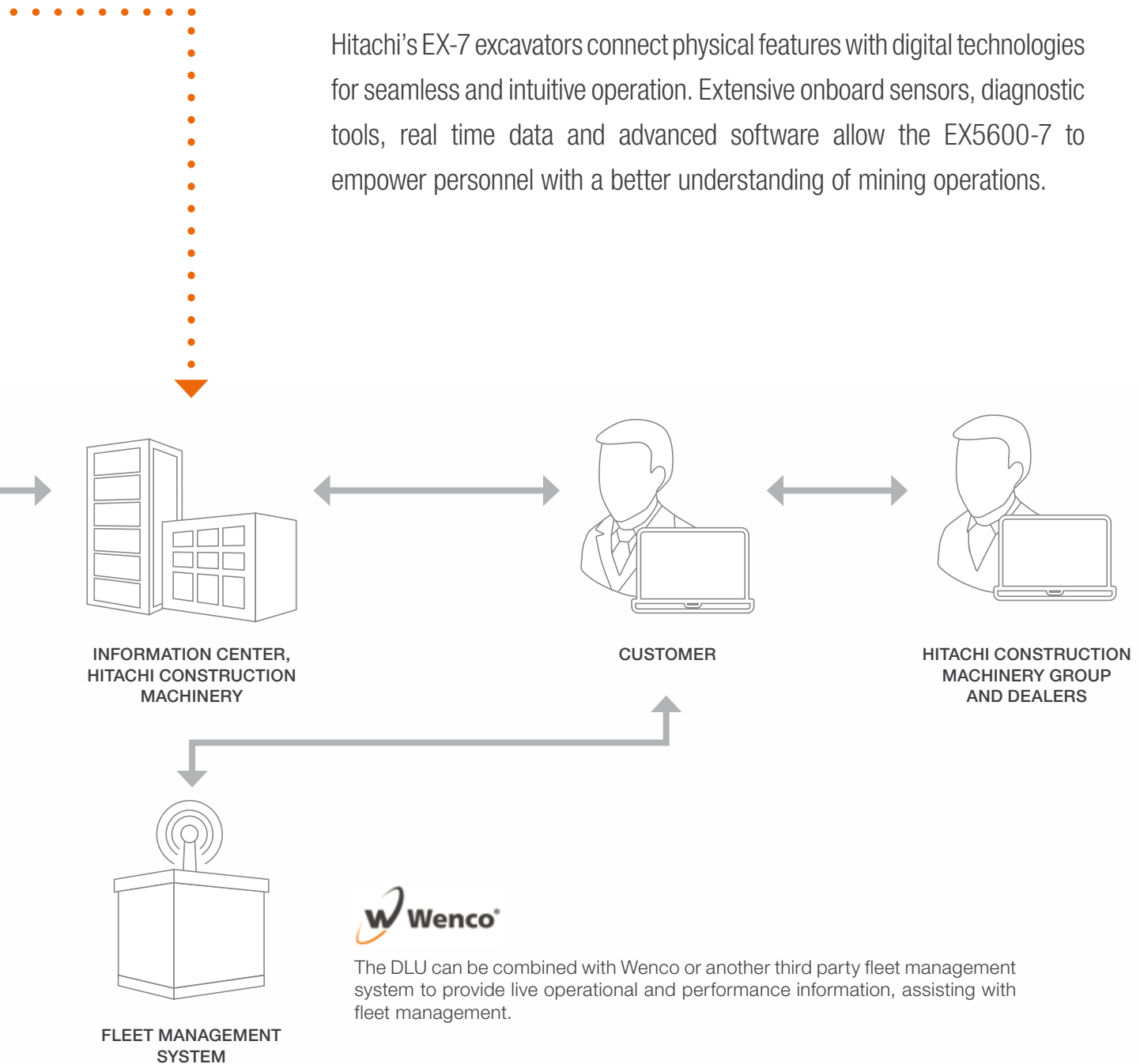

Aerial Angle (OPTIONAL)

Aerial Angle provides the operator with a real-time continuous birds-eye view around their excavator. Cameras strategically mounted on the machine combine to a single aerial view of the EX5600-7 surroundings. Multiple screen display options can be selected on the cab's 7-inch Aerial Angle monitor for ease of operation.

SPECIFICATIONS

WORKING RANGES

Loading Shovel

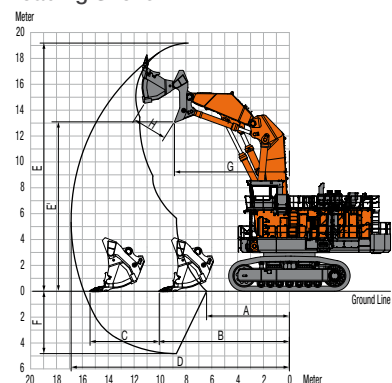

(Unit:mm)

A:	Minimum Digging Distance	6 400
B:	Minimum Level Crowd Distance	10 050
C:	Level Crowd Distance	5 350
D:	Maximum Digging Reach	17 000
E:	Maximum Cutting Height	19 200
E:	Maximum Dumping Height	13 100
F:	Maximum Digging Depth	4 800
G:	Working Radius at Maximum Dumping Height	8 900
H:	Maximum Bucket Opening Width	2 700

Backhoe

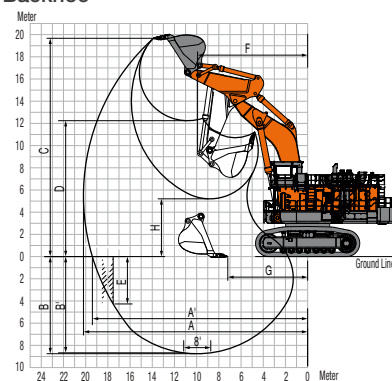

(Unit:mm)

A:	Maximum Digging Reach	20 200
A:	Maximum Digging Reach (on ground)	19 400
B:	Maximum Digging Depth	8 800
B:	Maximum Digging Depth (3° level)	8 700
C:	Maximum Cutting Height	19 700
D:	Maximum Dumping Height	12 200
E:	Maximum Vertical Wall	4 300
F:	Minimum Swing Radius	9 900
G:	Minimum Level Crowd Distance	7 200
H:	Minimum Dumping Height	5 200

DIMENSIONS

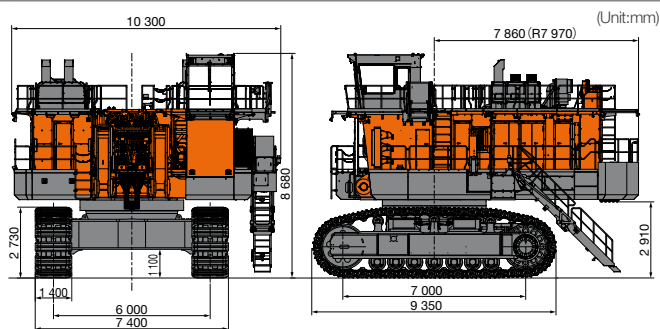

PASS MATCH

Best match: 4-6 passes

Potential match: 3-8 passes

Model	Bucket capacity*	60 t class truck	100 t class truck	EH3500AC-3	EH4000AC-3	EH5000AC-3
EX3600-7	BH (22 m ³)		3	5	6	8
	LD (22 m ³)		3	5	7	
EX5600-7	BH (34 m ³)			3	4	5
	LD (29 m ³)			4	5	7
EX8000-7	BH (43 m ³)				3	4
	LD (40 m ³)			3	4	5

Note: * ISO heaped
 Best match

ENVIRONMENT

Auto control air conditioner contains fluorinated greenhouse gases ,
 Refrigerant type: HFC-134a, GWP: 1 430, Amount: 2.85 kg, CO2e: 4.08 ton.

UPPERSTRUCTURE

Swing speed	3.3 min ⁻¹ (rpm)
Fuel tank capacity	11 300 L
DEF tank capacity	356 L

(Cummins T4F only)

HYDRAULIC SYSTEM

Main pumps	12 variable-displacement, axial piston pumps for front attachment, travel and swing
Pressure setting	29.4 MPa (300 kgf/cm ²)
Max. oil flow	8x 375 L/min, 4 x 425 L/min

UNDERCARRIAGE

Travel speeds	High: 0 to 2.3 km/h Low: 0 to 1.6 km/h
Maximum traction force	2 230 kN (227 000 kgf)
Gradeability	58 % (30 degree) max.

WEIGHTS AND GROUND PRESSURE

Loading Shovel

Equipped with 29 m³ (ISO heaped) bottom dump bucket

Shoe width	Weight	Ground pressure
1 400 mm	544 000 kg	244 kPa (35.4 psi)

Backhoe

Equipped with 34 m³ (ISO heaped) bucket

Shoe width	Weight	Ground pressure
1 400 mm	549 000 kg	246 kPa (35.7 psi)

Cummins T4F configuration

ATTACHMENTS

Loading Shovel

Bucket Capacity (ISO heaped)

27.0 m³ : Material density 1 900 kg/m³ or less
 29.0 m³ : Material density 1 800 kg/m³ or less

Backhoe

Bucket Capacity (ISO heaped)

34.0 m³ : Material density 1 800 kg/m³ or less

ENGINE

Model	Cummins QSKTA50-CE(FCO,T4F)
Rated power @1 800 min ⁻¹ (rpm)	
ISO14396	2 x 1 119 kW (1 520 PS)
Piston displacement	2 x 50 L

Model	MTU 12V4000 C13R(FCO)
Rated power @1 800 min ⁻¹ (rpm)	
ISO14396	2 x 1 150 kW (1 563 PS)
Piston displacement	2 x 57.2 L

Model	MTU 12V4000 C15(T4F)
Rated power @1 800 min ⁻¹ (rpm)	
ISO14396	2 x 1 150 kW (1 563 PS)
Piston displacement	2 x 57.2 L

Before using a machine with a satellite communication system or telecommunication system, please make sure that the satellite communication system or telecommunication system complies with local regulations, safety standards and legal requirements. If not so, please make modifications accordingly.

These specifications are subject to change without notice. Illustrations and photos show the standard models, and may or may not include optional equipment, accessories, and all standard equipment with some differences in color and features. Before use, read and understand the Operator's Manual for proper operation.