

EX-7 series

HITACHI

Reliable solutions

EX8000



HYDRAULIC EXCAVATOR

Model Code: EX8000-7 (Fuel Consumption Optimization)
Engine Rated Power: Cummins: 2 x 1 450 kW (1 944 HP)
MTU: 2 x 1 450 kW (1 944 HP)
Operating Weight: Cummins Loading Shovel: 827 000 kg
Backhoe: 839 000 kg
MTU Loading Shovel: 826 000 kg
Backhoe: 838 000 kg
Bucket: Loading Shovel: ISO Heaped: 43.0 m³
Backhoe: ISO Heaped: 43.0 – 48.0 m³

Model Code: EX8000-7B (Tier 4 Final)
Engine Rated Power: Cummins: 2 x 1 450 kW (1 944 HP)
MTU: 2 x 1 500 kW (2 012 HP)
Operating Weight: Cummins Loading Shovel: 830 000 kg
Backhoe: 842 000 kg
MTU Loading Shovel: 828 000 kg
Backhoe: 840 000 kg
Bucket: Loading Shovel: ISO Heaped: 43.0 m³
Backhoe: ISO Heaped: 43.0 – 48.0 m³

Model Code: EX8000-7E
Power Output: 2 x 1 200 kW
Bucket: Loading Shovel: ISO Heaped: 43.0 m³
Backhoe: ISO Heaped: 43.0 – 48.0 m³



Introducing the **NEW EX8000-7**

With more than 100 years of experience across group companies, Hitachi is an industry pioneer for mining excavators. The new EX-7 series showcases Hitachi's leading edge with innovative technologies and proven, trusted design.

Hitachi's largest excavator brings you advanced fuel optimization technologies, state-of-the-art safety features, and a focus on easy maintenance and operation. With Hitachi's EX8000-7, your site can achieve more than ever before.







ENGINE OPTIONS

CUMMINS

2 x Cummins QSK60, 16 cylinder, 60 L, turbo-charged, after-cooled 1 450 kW (1 944 HP)

Options:

Cummins diesel engine U.S.A. E.P.A. Tier 4 conforming model, with Diesel Exhaust Fluid (DEF) tank

Cummins diesel engine Fuel Consumption Optimization (FCO) model

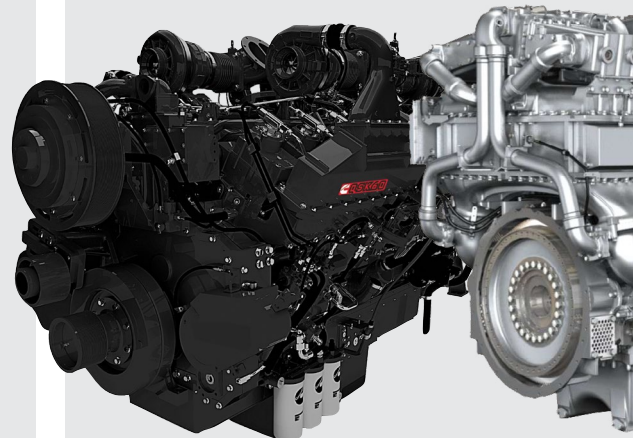

designed for

SUSTAINABILITY

Hitachi's EX-7 excavators are built on the philosophy that machines shouldn't have to sacrifice performance to be sustainable. This philosophy is evident in the EX8000-7 with energy-optimizing solutions, including electronically controlled hydraulic pumps, optimized cooling package, enhanced hydraulic circuits, and a choice of emission configurations to meet regulatory requirements, all combining to help operations minimize costs and maximize productivity.

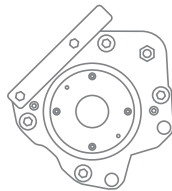

MAIN PUMP ELECTRIC REGULATORS

Each individually controlled hydraulic pump has its own electric regulator, enhancing engine power, lowering fuel consumption, and increasing productivity to lower the total cost of operation.

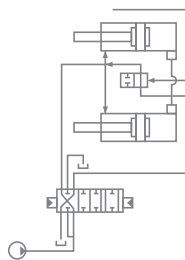

HYDRAULIC REGENERATION CIRCUIT

The flow regeneration valve fitted to the hydraulic system reduces pump demand, ultimately reducing power requirements from the hydraulic system and engine. The result is lower fuel consumption and improved pump life.

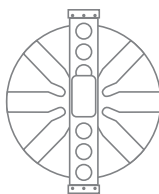

HYDRAULIC OIL COOLER

A larger hydraulic oil cooler with variable speed fan reduces energy demand and creates a more reliable hydraulic system. The oil cooler is separated from the radiator to reduce hydraulic oil temperatures, increase hydraulic service life, and improve maintainability.

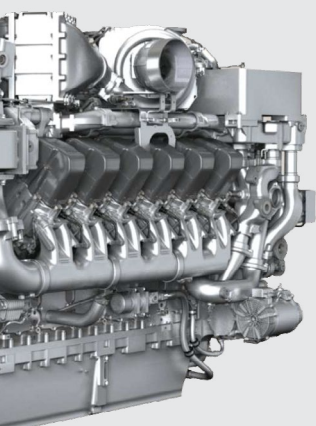

MTU

2 x MTU 12V4000, after-cooled, 12 cylinder, 57.2 L

Options:

MTU diesel engine U.S.A. E.P.A. Tier 4 conforming 2-stage turbo-charged model 1 500 kW (2 012 HP)

MTU diesel engine Fuel Consumption Optimization (FCO) single-stage turbo-charged model 1 450 kW (1 944 HP)

HITACHI AC ELECTRIC MOTOR

The EX8000-7E electric excavator is available, operating with the Hitachi AC electric motor

Options:

2 x electric motor (1 200 kW)
50Hz, 6 000 V, 6 600 V

2 x electric motor (1 200 kW)
60 Hz, 6 600 V, 7 200 V

Please contact your local Hitachi dealer for other specifications

designed for

PRODUCTIVITY

With advanced technology at its core, Hitachi's largest EX-7 excavator is engineered to tackle the most demanding jobs in 24/7 operations. Reliable digging power and a performance-focused front attachment design give the EX8000-7 the capability to deliver consistent results.



FRONT ATTACHMENT

With a front attachment design that prioritizes performance, the EX8000-7 achieves superior productivity across different digging profiles.

The boom and arm utilize a full-box section design to evenly distribute stress and provide ease of maintenance.



LOADING SHOVEL

The Loading Shovel attachment is designed to maximize durability and operator control. The EX8000-7 now has a larger 43 m³ bucket designed to increase loading capability with a tilt angle that enhances operational efficiency.

LOADING SHOVEL EXCAVATING FORCE

Arm crowding force on ground

2 420 kN (246 800 kgf)

Bucket digging force

2 230 kN (227 400 kgf)

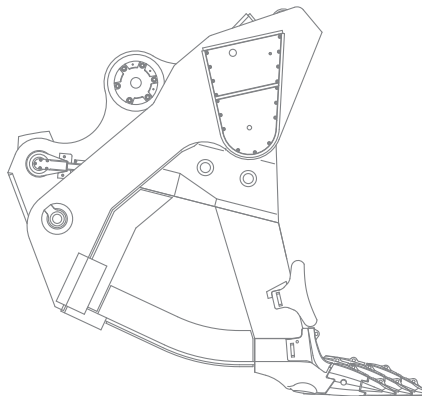

BACKHOE

The Backhoe attachment is designed using computer aided box frame analysis to determine the optimal structure for integrity and longevity. Complete with a floating pin and bush, the 43 m³ bucket is designed to maximize productivity.

BACKHOE EXCAVATING FORCE

Arm crowding force

1 770 kN (180 700 kgf)

Bucket digging force

2 020 kN (206 000 kgf)

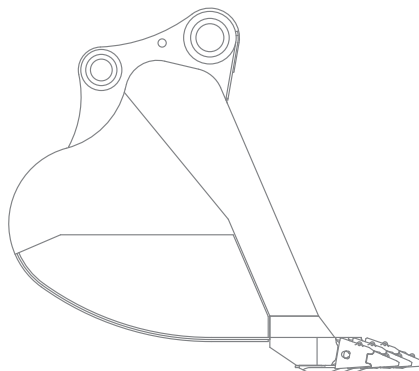

designed for SAFETY

Hitachi understands an operation's most valuable asset is its people. That's why the EX-7 series is designed with safety at the forefront, providing excellent protection in both operation and maintenance. An on-board inclinometer, improved machine access, and a dual isolator switch as standard are just some of the features that make the EX8000-7 one of the safest machines on the market.

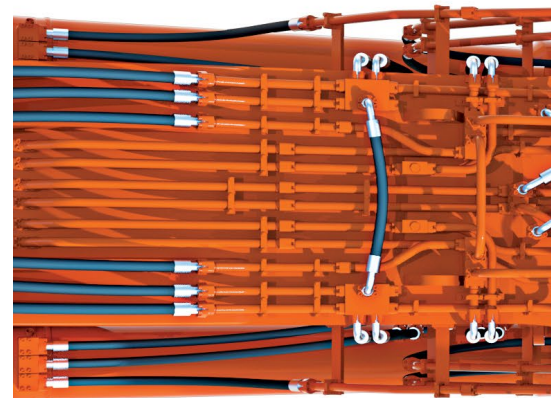
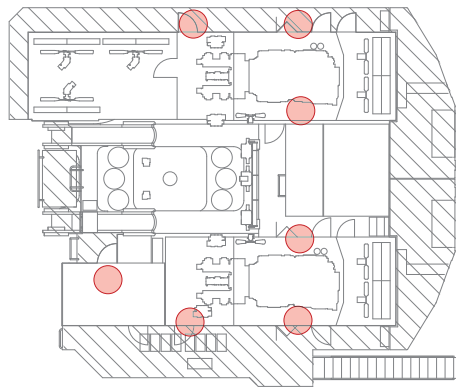

PERIMETER MONITORING CAMERAS (OPTIONAL)

Perimeter monitoring cameras offer better visibility of the surrounding area, reducing blind spots for the operator. Two cameras are located at both the front and rear of the excavator and are linked to monitors inside the cab.



EMERGENCY ESCAPE CHUTE

An escape chute has been added to the side of the cab for use in an emergency. The chute allows evacuees to descend vertically down from the machine, providing a safe and fast route of escape when all other means of exit are blocked.

ENGINE STOP SWITCHES

Engine stop switches have been placed in easily accessible areas: four in the engine room, two in the pump room, and one emergency stop switch in the cab.



ON-BOARD INCLINOMETER

The on-board inclinometer assists the operator to work within the safe limits of the machine, with two predetermined safety limits providing extra assurance. If the first safety limit is exceeded, the operator receives a visual alert prompting them to take corrective action. The alert escalates to an audible alarm if the second safety limit is breached.



DUAL ISOLATOR SWITCH

The conveniently located dual isolator switch offers the option to deactivate the engine and battery individually.

When inspections and maintenance are required, the battery isolator provides the benefit of isolating both the positive and negative terminals of the battery for a safe working environment. The engine isolator deactivates the engine starter motor while allowing battery power to the electric system for troubleshooting, to enhance safety and maintainability.

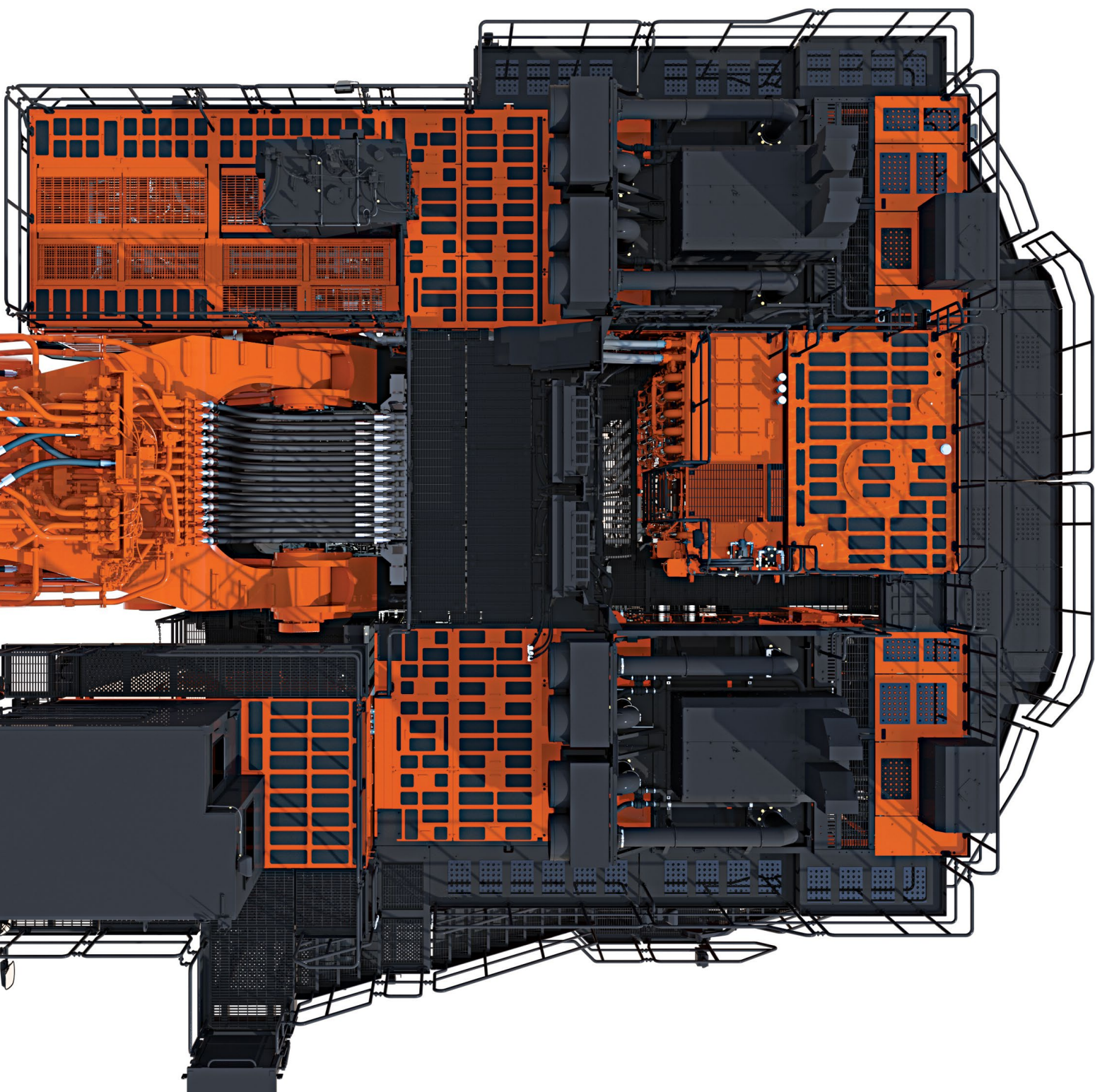

ACCESS AND WALKWAYS

Anti-slip walkways and specially designed handrails reduce the risk of tripping when maneuvering around the machine, providing ease of access for operators and maintenance personnel.

Wide, low-gradient, non-slip, hydraulic folding stairs allow for easy and safe access to the machine.

designed for

OPERATOR COMFORT

Hitachi's EX-7 excavators are designed to work around the clock in often challenging conditions, so a comfortable operating environment is essential. The EX8000-7's ergonomic layout is equipped with features like electronic joysticks, an intelligent multi-functional display, advanced air suspension seating, and improved climate control, to reduce operator fatigue by making machine operation as effortless as possible.



CLIMATE CONTROLLED AIR CONDITIONING

The pressurized cab's climate controlled air conditioning helps to overcome environmental extremes. Optimized filtering of interior and exterior air combined with the new flexi-vent system provides a personalized and balanced environment that meets operator demands.

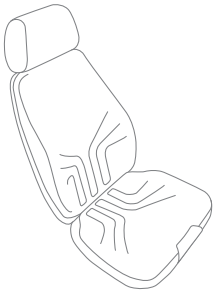

OPERATOR SEAT

Specifically designed for use in the mining industry, the automatic weight-adjusting air suspension seat calculates optimal cushioning to match the operator's weight, enhancing comfort and minimizing vibration.



ELECTRONIC JOYSTICKS

Integrated electronic joysticks connected to the machine's microprocessor enable precise and almost effortless operation, minimizing operator fatigue and improving operational performance.

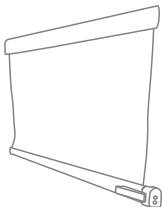

ROLL SCREENS

Retractable front and side roll screens protect the operator from UV glare and reduce heat buildup in the cab, improving the efficiency of the climate controlled air conditioner for a superior operating environment.

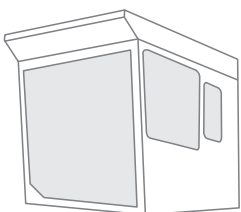

OPERATOR CABIN

Use of laminated tinted windows reduces heat and glare in the cab, while sound-suppression enhances operator comfort and ergonomics. The Level II Operator Protective Guard (OPG) provides secure protection from falling objects, ensuring operator safety.



MULTI-FUNCTIONAL DISPLAY

Fitted with an LED back-light to improve clarity and reduce glare, the multi-functional display provides key machine information and performance indicators through the use of an integrated dial switch interface.



designed for

EASE OF MAINTENANCE

Hitachi's EX-7 series is designed to keep maintenance safe and simple, to minimize downtime and improve productivity. The modular arrangement of the EX8000-7 allows spacious passageways and work platforms for serviceability, and a range of innovative features create the ease of maintenance Hitachi is renowned for.



CENTRALIZED LUBRICATION SYSTEM

A centralized fast-filling system provides easy access from the ground to refill and evacuate lubricants, water, grease, oil and fuel. The fast-filling system can be fitted with an optional quick coupler.



LUBRICATION PIPING COVER

A swing circle cover has been added to the outside of the swing bearing, protecting the lubrication piping from debris damage.



GREASE-LESS CENTER JOINT

The new center joint employs the machine's hydraulic oil to self-lubricate, reducing the need for daily maintenance.



AUTO-LUBRICATION SYSTEM

A new auto-lubrication system comes with a 1 000 L large capacity grease tank, new grease pump, in-line grease filter with breather, grease level indicator in cab and provision for fitment of a second grease pump in the lubrication tank. These features provide a more reliable system with less downtime.

MAINTENANCE ACCESS

Wide center walkways and open service areas offer ease of access for daily maintenance tasks and make engine, hydraulic, and electrical component inspections easy.

SWING MOTOR ACCESSIBILITY

Main piping is built around the swing motor so it can be quickly and easily accessed during maintenance without the need to remove components.



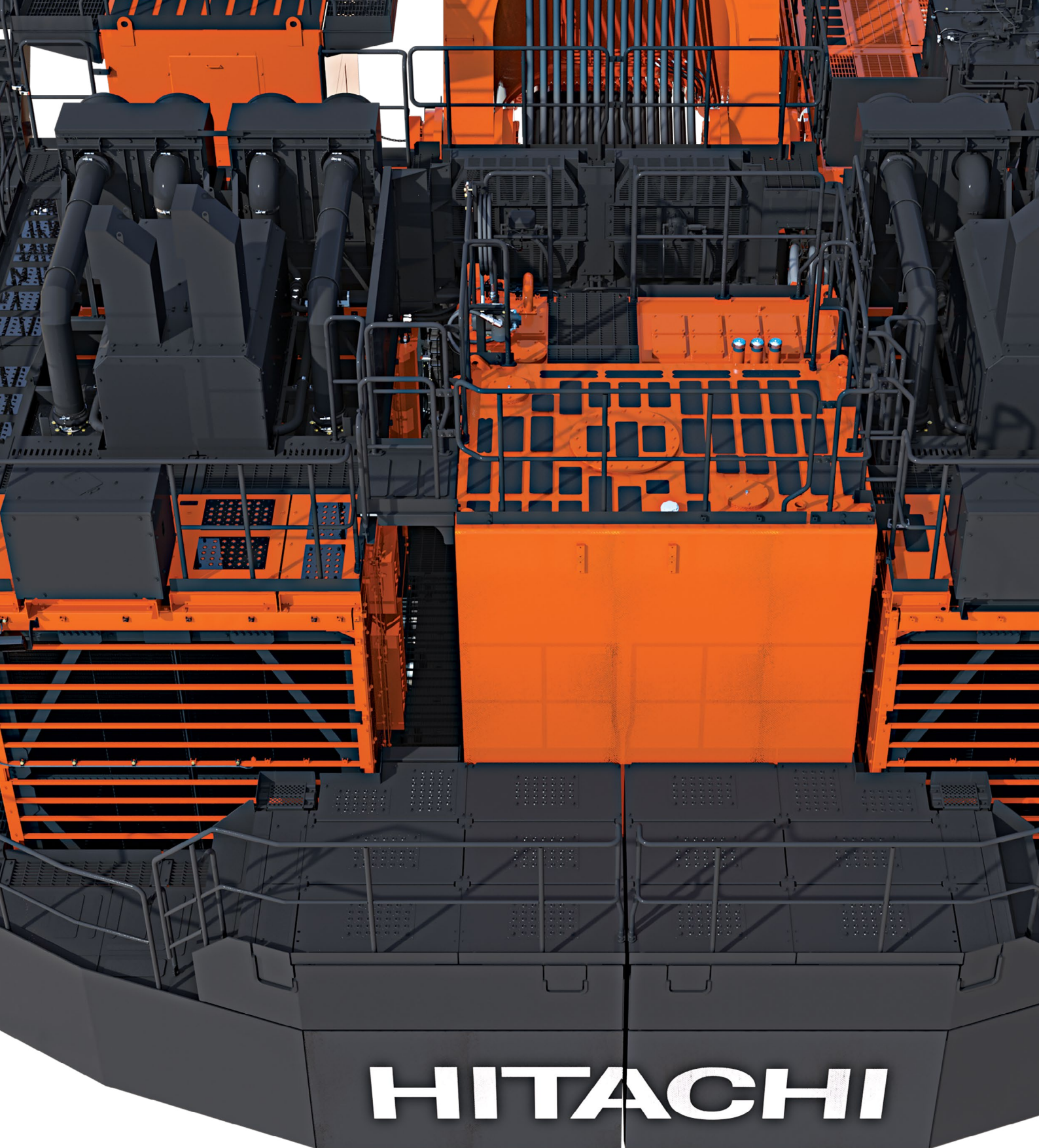

HITACHI

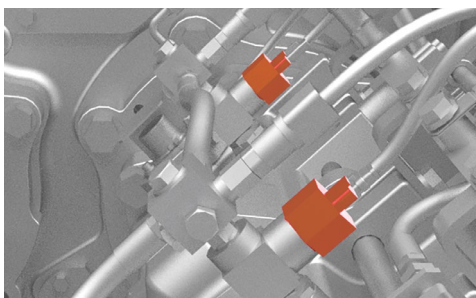

CONTAMINATION SENSORS

Contamination sensors are located on main hydraulic pumps, travel motors and swing motors to detect any contaminants that may cause damage to the hydraulic system. Sensors alert the operator of potential contaminants and record the fault code in the Data Logging Unit (DLU) with the capability to remotely advise maintenance personnel.



designed for

DURABILITY

Cutting edge technologies and robust design come together to make Hitachi's EX-7 series of excavators the most durable yet. Advanced computer modelling, specialized forgings, and specially designed track shoes are just some of the features manufactured to exacting standards on the EX8000-7 to maximize longevity and contribute to lower operating costs.

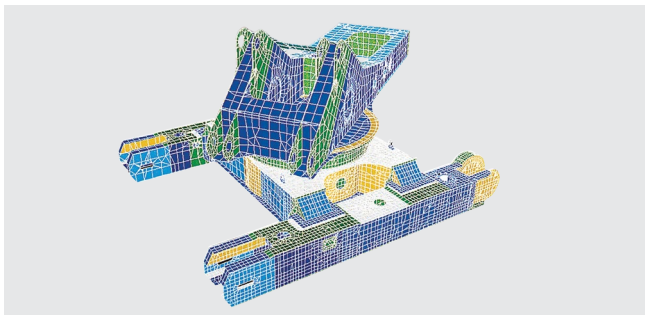

RIGID BOX DESIGN

Computer assisted analysis has been used to determine the most effective design for frame longevity, ensuring the EX8000-7 withstands the demands of any mining operation.

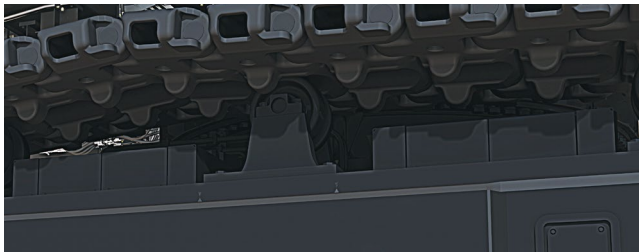

UPPER ROLLERS

The EX8000-7 undercarriage has three double-sided, pedestal-designed upper rollers on each side of the track frame. These rollers maintain track shoe clearance and provide protection from debris buildup, reducing shoe and roller wear for a more reliable undercarriage system.

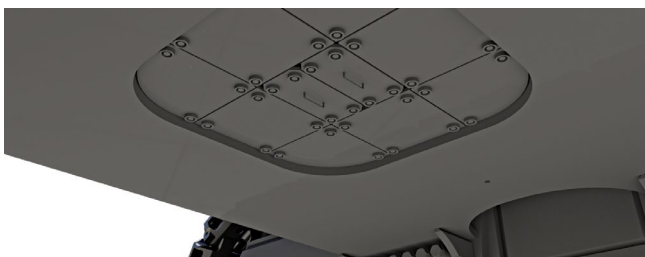

CENTER FRAME UNDERGUARD (OPTIONAL)

A newly designed heavy duty guard protects hoses and accumulators located in the track center frame from rocks and debris ingress, providing extra protection and reliability.



CENTER TRACK FRAME

Hitachi's exclusive center track frame delivers optimal stress dispersion through the use of specially designed forged steel parts to reduce the chance of failure in critical high-stress areas. This provides a stronger frame with improved durability.



TRACK SHOES

Hitachi's classic track shoe design has been applied to mitigate premature wear of the drive-lugs. Each shoe is induction hardened using Hitachi's proven methods to deliver a superior and more durable solution.

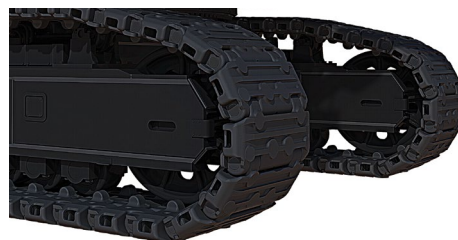

OIL-FILLED ROLLERS & IDLERS

Oil-filled idlers and upper and lower rollers eliminate the need for daily lubrication, helping reduce maintenance costs.

designed for

RELIABILITY

Hitachi's long-standing commitment to engineering excellence makes the EX-7 series one of the most reliable on the market. The EX8000-7 comes with a number of clever features focused on increasing reliability and safely maximizing output for operations.



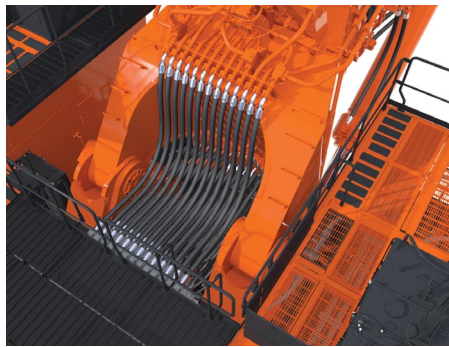

FRONT ATTACHMENT HOSES

Hitachi's hose design has been tested on a high cyclic fatigue rate to maximize longevity and improve safety. Front attachment hoses have been rearranged from the traditional arch style to an underslung configuration, removing the need for clamping, reducing chafing and increasing reliability.

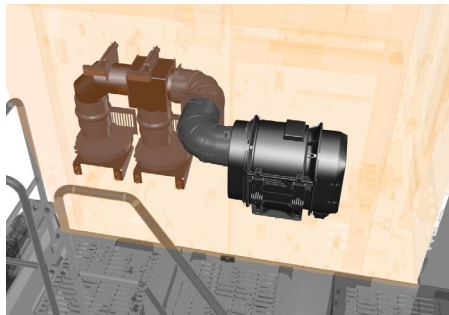

CAB RISER PRESSURIZER

The cab riser now features a pressurizer system to reduce dust infiltration, extending service life of the electronic components and devices within.

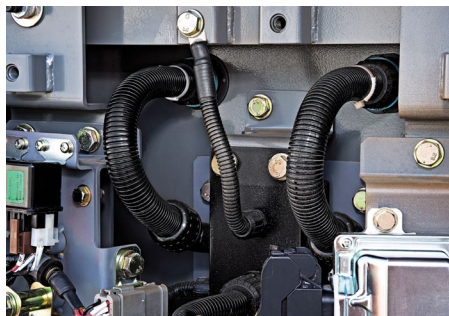

SOLID CONDUIT WIRE HARNESSES

Newly introduced solid conduit harnesses and junction boxes prevent dust and moisture ingress, improving longevity. Electrical harnesses between junction boxes can be replaced individually, reducing maintenance time and cost.



OPERATING LIGHTS

Strategically placed long-life LED working lights provide assured reliability for night operations.

ELECTRONIC CYLINDER STROKE CONTROL

The new on-board electronic controller receives signals from angle sensors fitted to the main frame, boom and arm to control the pump flow rate and cylinder speed. Shock at stroke end of the cylinder cycle is reduced, improving operator comfort and lowering impact on cylinders and structures for more reliable operation.



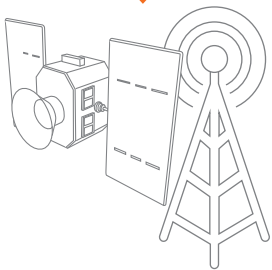

ANTENNA (GPRS) OR
SATELLITE

SATELLITE / GPRS COMMUNICATION (OPTIONAL)

Standard machine information is transmitted daily through either satellite or GPRS (General Packet Radio Service) communication, sending data directly to the Hitachi Global e-Service platform to support the mining operation.

Global e-Service

Global e-Service is a Hitachi web-based platform that sends vital machine information directly to the customer in a readily accessible format.

WIRELESS INTERFACE

Detailed machine information can be remotely downloaded from the Data Logging Unit (DLU) via the Wireless Interface Unit (WIU), providing vital operational and performance data.

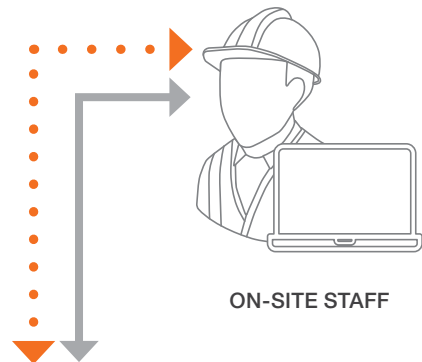

ON-SITE STAFF



designed for
INTELLIGENCE

Hitachi is dedicated to the advancement of mining through digital innovation and connectivity. The EX8000-7 features extensive onboard sensors, diagnostic tools, and advanced software to deliver exceptional insights, empowering operations to achieve more in real time.

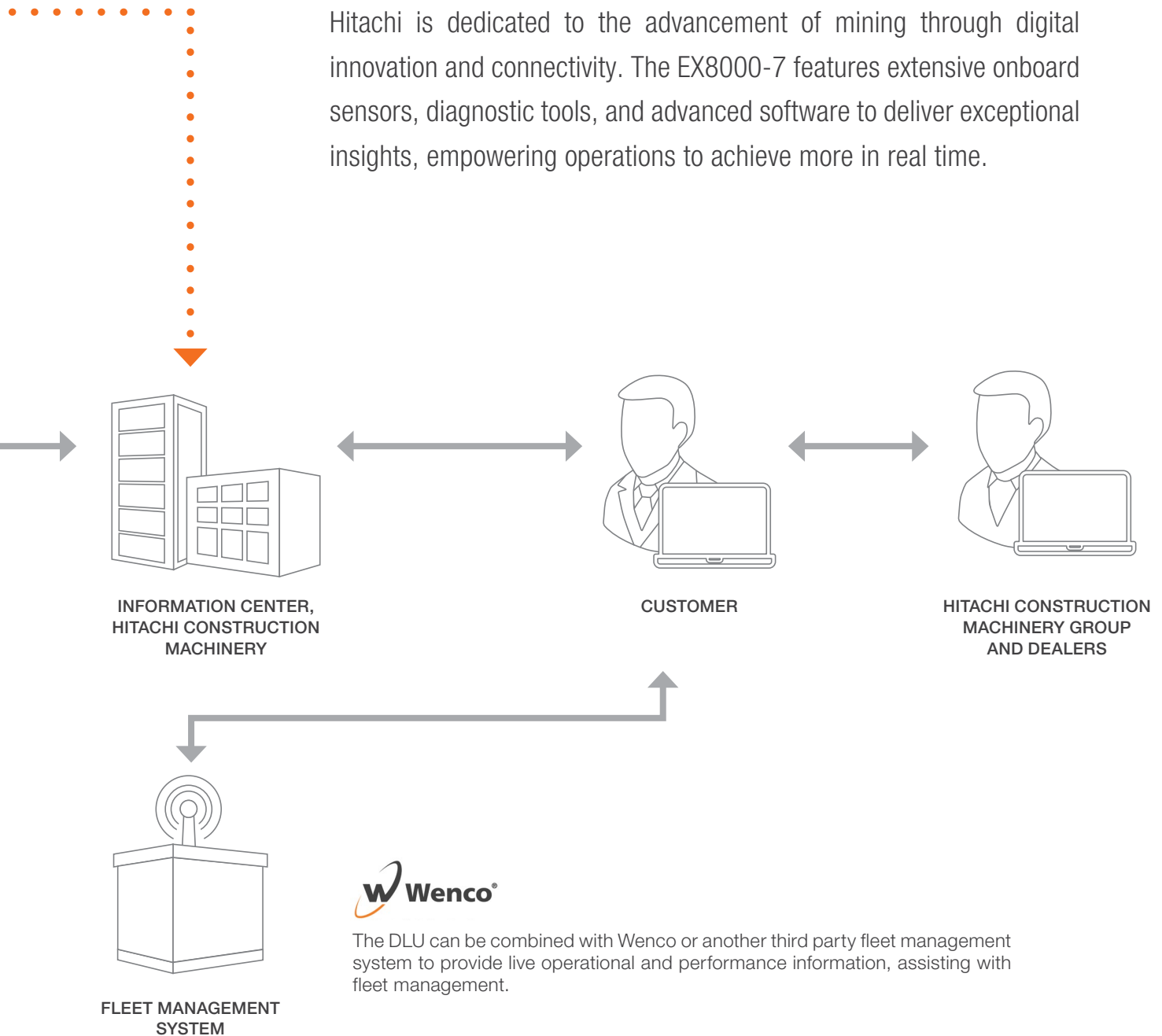

Aerial Angle (OPTIONAL)

Aerial Angle provides the operator with a 360° view around their excavator. Cameras strategically mounted on the machine generate a single aerial view of the EX8000-7 surroundings. Multiple screen display options can be selected on the cab's 7-inch Aerial Angle monitor for ease of operation.

SPECIFICATIONS

WORKING RANGES

Loading Shovel

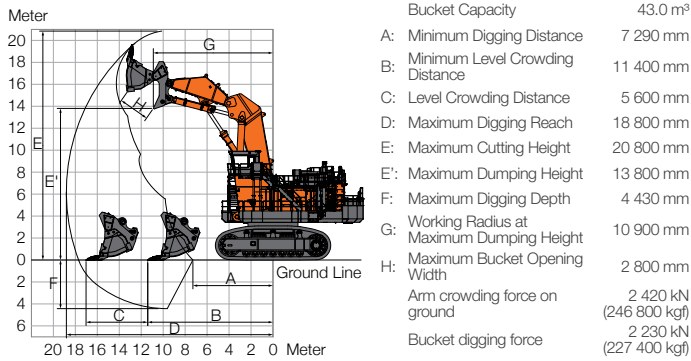

Backhoe

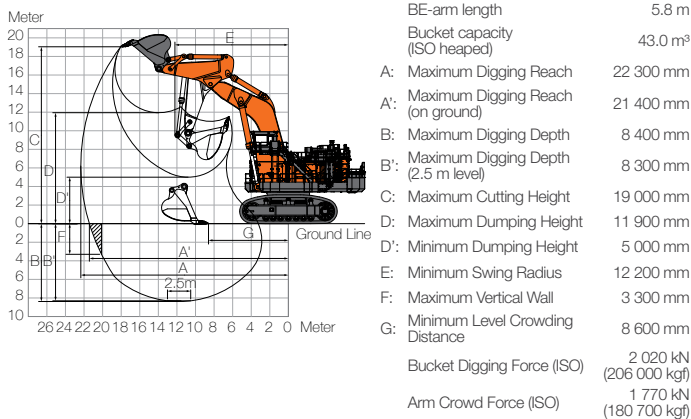

DIMENSIONS

(Unit:mm)

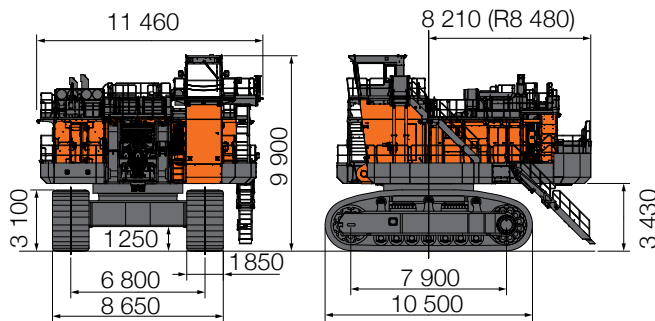

PASS MATCH

Best match: 4–6 passes

Potential match: 3–8 passes

Model		60t class truck	100t class truck	EH3500AC-3	EH4000AC-3	EH5000AC-3
EX3600-7	BH (22 m ³)		3	5	6	8
	LD (22 m ³)		3	5	7	
EX5600-7	BH (34 m ³)			3	4	5
	LD (29 m ³)			4	5	7
EX8000-7	BH (43 m ³)				3	4
	LD (43 m ³)				3	4

UPPER STRUCTURE

Swing speed	3.9 min ⁻¹ (rpm)
Fuel tank capacity	14 900 L
DEF tank capacity (Cummins T4F only)	2 x 475 L

HYDRAULIC SYSTEM

Main Pumps	16 variable-displacement, axial piston pumps for front attachment, travel and swing
Pressure setting	29.4 Mpa (300 kgf/cm ²)
Max. oil flow	16 x 500 L/min

UNDERCARRIAGE

Travel speeds	High: 0 to 2.0 km/h Low: 0 to 1.4 km/h
---------------	---

WEIGHTS AND GROUND PRESSURE

Loading Shovel

Equipped with 43.0 m³ (ISO heaped) bottom dump bucket

Shoe width	Weight	Ground pressure
1 850 mm	830 000 kg	250 kPa (2.55 kgf/cm ²)

Backhoe

Equipped with 43.0 m³ (ISO heaped) bottom dump bucket

Shoe width	Weight	Ground pressure
1 850 mm	842 000 kg	253 kPa (2.58 kgf/cm ²)

Cummins T4F configuration

ATTACHMENTS

Loading Shovel

Bucket Capacity (ISO heaped)

43.0 m³ : Material density 1 800 kg/m³ or less

Backhoe

Bucket Capacity (ISO heaped)

43.0 m³ : Material density 1 800 kg/m³ or less
48.0 m³ : Material density 1 800 kg/m³ or less

ENGINE

Model	Cummins QSKTA60-CE (FCO, T4F)
Rated power @ 1 800 min ⁻¹ (rpm)	
ISO 14396	2 x 1 450 kW (2 x 1 944 HP)
Piston displacement	2 x 60.0 L
Model	MTU 12V4000 C33 (FCO)
Rated power @ 1 800 min ⁻¹ (rpm)	
ISO 14396	2 x 1 450 kW (2 x 1 944 HP)
Piston displacement	2 x 57.2 L
Model	MTU 12V4000 C35 (T4F)
Rated power @ 1 800 min ⁻¹ (rpm)	
ISO 14396	2 x 1 500 kW (2 x 2 012 HP)
Piston displacement	2 x 57.2 L

ENVIRONMENT

Auto control air conditioner contains fluorinated greenhouse gases.
Refrigerant type: HFC-134a, GWP: 1430, Amount: 3.50 kg, CO₂e: 5.01 ton.

Before using a machine with a satellite communication system or telecommunication system, please make sure that the satellite communication system or telecommunication system complies with local regulations, safety standards and legal requirements. If not so, please make modifications accordingly.

These specifications are subject to change without notice. Illustrations and photos show the standard models, and may or may not include optional equipment, accessories, and all standard equipment with some differences in color and features. Before use, read and understand the Operator's Manual for proper operation. The machines shown in this brochure are so positioned for the sake of demonstrations. When leaving the machine, be sure to rest the bucket on the ground.